



MK-D700500Z2

**Ceiling-mounted LED
Surgical Lighting System**

Ceiling-mounted LED Surgical Lighting System

MK-D700500Z2

MAIN FEATURES

- Simple and clear system operation interface, simple and easy to understand
- High efficient and durable OSRAM LED light source without thermal radiation
- Flexible design with PWM stepless dimming and adjustable color temperature
- Switch lighting mode with one click: standard mode, endoscope mode, low light mode
- Use PWMA optical lens, overall aluminum substrate heat dissipation, with a unique light concentrating technology, high light efficiency and low power consumption

MK-D700500Z2

Ceiling-mounted LED Surgical Lighting System

Three lighting modes

Three Lighting Mode suit for various operation with different lighting requirement.



Standard mode

In this mode, surgical light can adjust brightness according to requirement, suit for general surgery.



Endoscope Mode

In this mode, high color temperature can not be adjustable, suit for minor surgery like endoscope surgery.



Low Light Mode

This mode can be used for small operations with low brightness requirements, and is suitable for pet hospitals, beauty salons and other places.

Uniform Adjustable Light Spot

Multi layer spot overlapping technology, central focusing device, clear operation field



Multi layer spot overlapping technology



Adjustable Light Spot Diameter

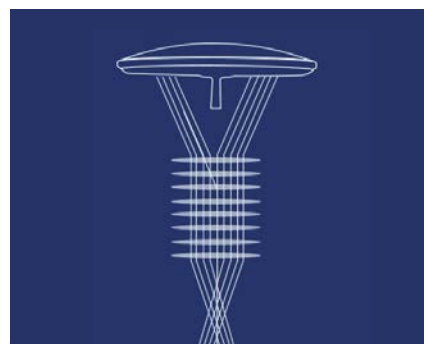

Illumination depth

MK-D700500Z2

Ceiling-mounted LED Surgical Lighting System

Color Temperature and Brightness Easy Adjustment

- Color rendering index , near to real color as soon as possible
- Digital dimming technology meets the brightness requirements of different surgeries
- Reasonable quantity and distribution design of high low color temperature light source, which achieve 4000-5000K color temperature adjustment

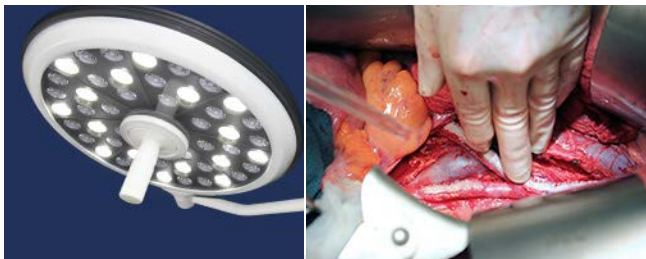

High color temperature



Low color temperature

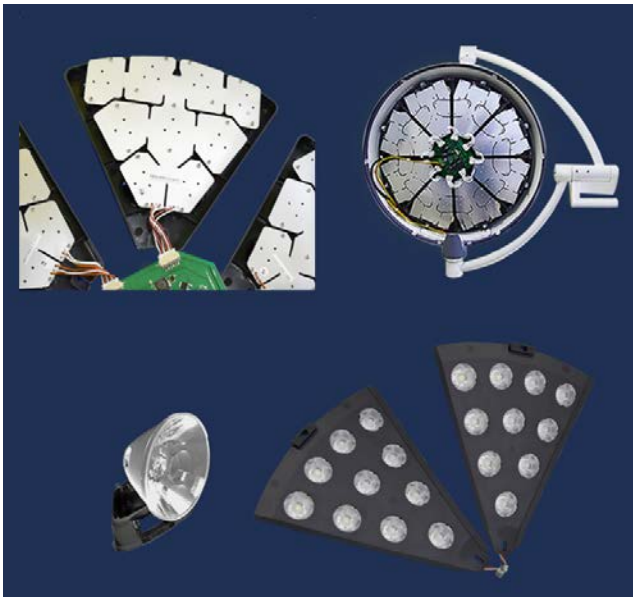

Excellent light source module design

- Lamphead with 80/48pcs LED light source, which are divided into multiple light source groups
- Excellent lighting collecting technology (lens focusing angle is reasonable), Excellent light efficiency
- Each group light source is controlled by CPU independently, if any group light source is broken, the light can still use
- Internal Light Source Structure: Engineering Plastic ABS + Aluminum Board, good heat dissipation and lighter weight

MK-D700500Z2

Ceiling-mounted LED Surgical Lighting System

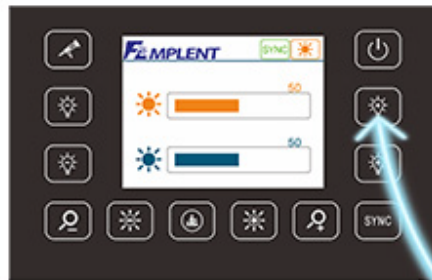

Mutual Control for Both Lamp Head

- Both lamphead controller can control mutually each other`s color temperature, endoscope, camera and others (knob dimmer have no this function)

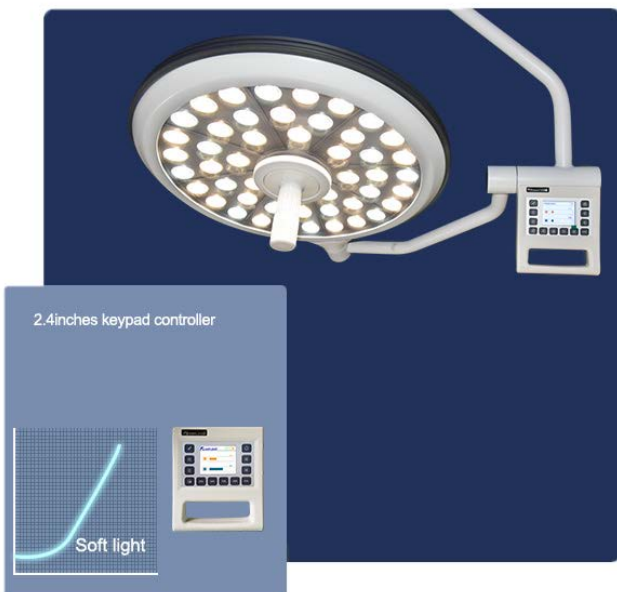
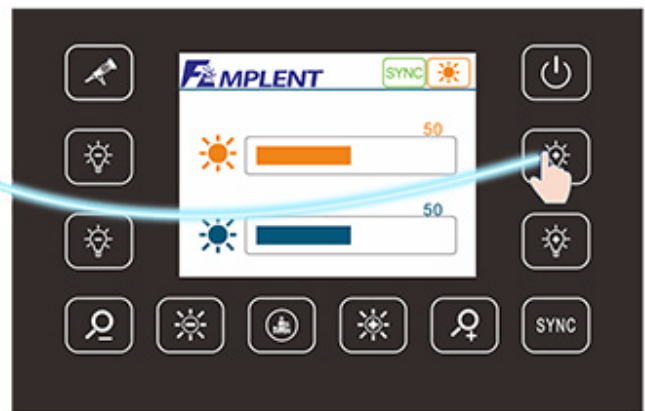

Easy Practical Operation

- Soft Light with Eye Protection
- Controllers for your optional

MK-D700500Z2

Ceiling-mounted LED Surgical Lighting System

Light Focus Adjustment Device

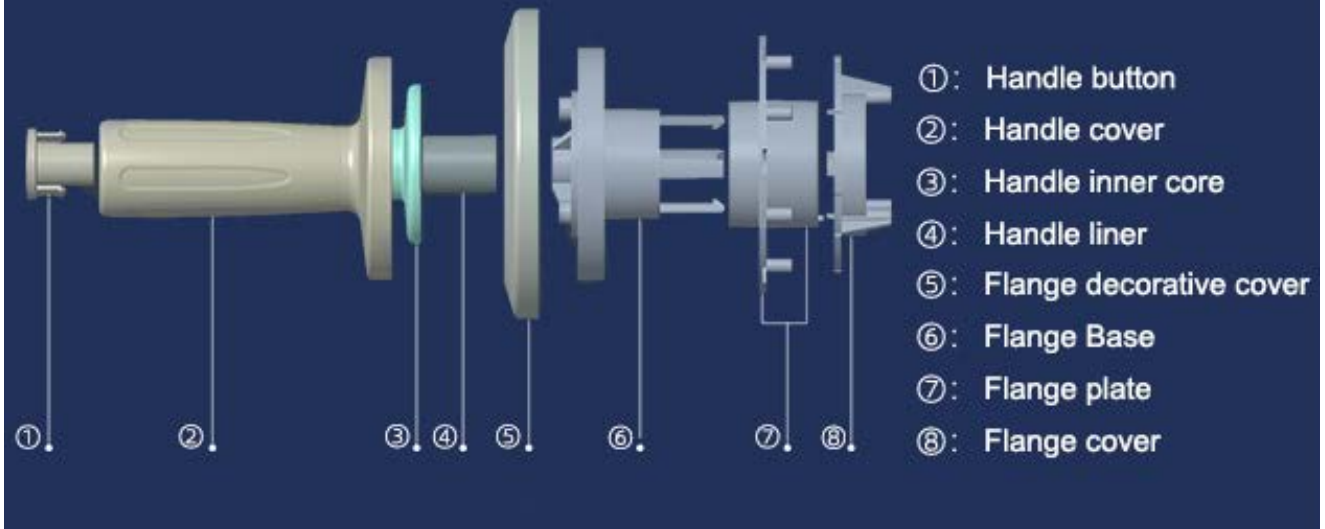

Focusing component

- Using screw rod to lift and adjust steplessly
- The sterilizer handle adopts a non-directional buckle design, disassembly and assembly more flexible
- Sterilizer handle adopts high-temperature resistant material, to achieve high-temperature and high-pressure steam sterilization



Optional HD Camera System

- Surgical Light can be equipped with built in camera or external camera system
- PWM technology, perfectly solving stroboscopic problem of the camera system
- Remote consultation, remote teaching, large-screen conference, etc. can be realized via the Internet and operating process can be recorded at the same time

MK-D700500Z2

Ceiling-mounted LED Surgical Lighting System

Thin lamp head design



500 Lamp Head



700 Lamp Head



Technical Paramter

Luminance(Lux)	40,000-160.0008 40.000-120.000
Diameter of light head(mm)	700 & 500
Number of bulbs	80 & 48
Color temperature(k)	3000-5000 adjustable
Color render index(Ra)	≥95% & ≥95% (adjustable)
Spot Diameter (mm)	120-260
LED bulb brand	Germany Osram
Number of bulbs (pcs)	80 & 48
LED Power (w)	75 & 45
Illuminance depth(mm)	600-1500 & 800-1500
Brightness adjustment	>50000
Bulb service life(H)	>50000
Voltage	AC110-240V 50/60Hz

Medik is a group focusing on surgical room solution and nursing care solution. We started to manufacture surgical table & lamp since 2011 with a professional team consisting of experienced designer and engineer from international top brand. With 10 years accumulation, Medik is becoming a new star to provide reliable product and valuable solution for surgical room.

Qualified with ISO9001, ISO13485, CE, Medik has successfully distributed the surgical products covering surgical table & lamp & pendant to international hospitals both domestic and overseas including many countries in Europe.

**YOU TUBE****MEDIK**

Pls scan the QR code for more info

www.mediksurgical.com | +86 139 6223 1292

Medik reserves the right to make changes without notice in design, specifications and models. The only warranty Medik makes is the express written warranty extended on the sale or rental of its products.